

Instruction Manual

Thank you for purchasing the HAKKO FX-100 Soldering Station.
Please read this manual before operating the HAKKO FX-100.
Keep this manual readily accessible for reference.

1. PACKING LIST AND PART NAMES

Please check to make sure that all items listed below are included in the package.

HAKKO FX-100 soldering station	1	Heat resistant pad	1
HAKKO FX-1001 soldering iron	1	Iron holder	1
Sleeve (Green)	1	Power cord	1
Sleeve (Gray)	1	Instruction manual	1
Cleaning wire	1		

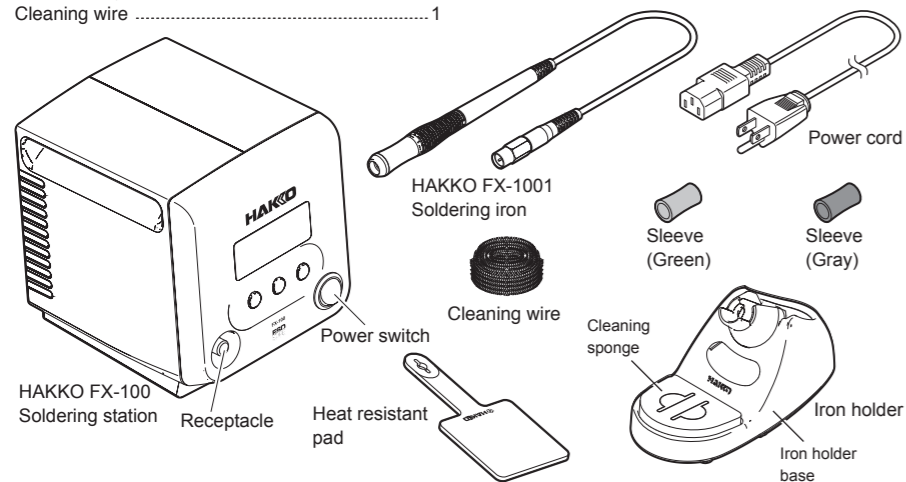

2. SPECIFICATIONS

Power consumption	28 W (85 W)
Tip series /	T31-01 Series / 450°C (840°F)
Tip temperature	T31-02 Series / 400°C (750°F)
Temperature stability	±1.1°C (±2.0°F)

● **Station**

Output power	50 W
Output frequency	13.56 MHz
Dimensions	127 (W) × 150 (H) × 167 (D) mm (5.0 × 5.9 × 6.6 in.)
Weight	3 kg (6.6 lb.)

● **HAKKO FX-1001 soldering iron**

Length of cord	1.3 m (4.3 ft.)
Total Length (w/o cord)	190 mm (7.5 in.) with T31-02D24 tip
Weight (w/o cord)	31 g (0.07 lb.) with T31-02D24 tip

NOTE:
This product is protected against electrostatic discharge.

* Specifications and design are subject to change without notice.

※ 各言語（日本語、英語、中国語、フランス語、ドイツ語、韓国語）の取扱説明書は以下のURL、HAKKO Document Portalからダウンロードしてご覧いただけます。
（商品によっては設定の無い言語がありますが、ご了承ください）
* 各言語（日本語、英語、中文、法語、ドイツ語、韓語）の使用説明書は通過以下网站的HAKKO Document Portal 下载参阅。
（有一部分的产品没有设定外语对应，请见谅）
* Instruction manual for the language, Japanese, English, Chinese, French, German and Korean can be downloaded from the following URL, HAKKO Document Portal.
(Please note that some language may not be available depending on the product.)

<https://doc.hakko.com>

CAUTION
This product includes such features as electrically conductive plastic parts and grounding of the handpiece and station as measures to protect the device to be soldered from the effects of static electricity. Be sure to observe the following instructions:
1. The handle and other plastic parts are not insulators, they are conductors. When replacing parts or repairing, take sufficient care not to expose live electrical parts or damage insulation materials.
2. Be sure to ground the unit during use.

3. WARNINGS, CAUTIONS AND NOTES

Warnings, cautions and notes are placed at critical points in this manual to direct the operator's attention to significant items. They are defined as follows:

- WARNING:** Failure to comply with a WARNING may result in serious injury or death.
- CAUTION:** Failure to comply with a CAUTION may result in injury to the operator, or damage to the items involved. Two examples are given below.
- NOTE:** A NOTE indicates a procedure or point that is important to the process being described.

WARNING

When power is ON, the tip will be hot. To avoid injury or damage to personnel and items in the work area, observe the following:

- Do not touch the tip or the metal parts near the tip.
- Do not allow the tip to come close to, or touch, flammable materials.
- Inform others in the area that the unit is hot and should not be touched.
- Turn the power off when not in use, or left unattended.
- Turn the power off when changing parts or storing the HAKKO FX-100.
- The unit is for a counter or workbench use only.
- This appliance can be used by children aged from 8 years and above and persons with reduced physical, sensory or mental capabilities or lack of experience and knowledge if they have been given supervision or instruction concerning use of the appliance in safe way and understand the hazards involved.
- Children shall not play with the appliance.
- Cleaning and user maintenance shall not be made by children without supervision.

To prevent accidents or damage to the HAKKO FX-100, be sure to observe the following:

CAUTION

- Do not use the HAKKO FX-100 for applications other than soldering.
- Do not allow the HAKKO FX-100 to become wet, or use it when hands are wet.
- Do not modify the HAKKO FX-100.
- Use only genuine HAKKO replacement parts.
- Be sure to hold the plug when inserting or removing the iron cord.
- Do not strike the iron against hard objects to remove excess solder. This will damage the iron.
- Be sure the work area is well ventilated. Soldering produces smoke.
- While using the HAKKO FX-100, don't do anything which may cause bodily harm or physical damage.

4. INITIAL SETUP

A. Iron holder

- This product includes two methods for cleaning the tip: a wire tip cleaner, and a sponge. Please be sure to soak the sponge in water before using.
- Set the iron holder.
 - Put the small cleaning sponge in one of the five holes in the iron holder base.
 - Add water to the iron holder base. The small sponge will keep the large sponge moist through capillary action.
 - Wet the large sponge, squeeze it dry and put it on the iron holder base.

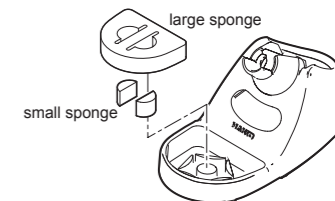

CAUTION
Using the sponge without water may damage the tips.

When using a Cleaning Wire

Place it in the iron holder as shown on the right. See "2.Using a Cleaning Wire" in section "7. MAINTENANCE"



B. Handpiece cord assembly

- Pass the iron cord through the hole in the heat resistant pad.
- Hold the head part of the T31 series tip (not included) with the heat resistant pad and insert the tip into the handpiece. Push until the tip stops.

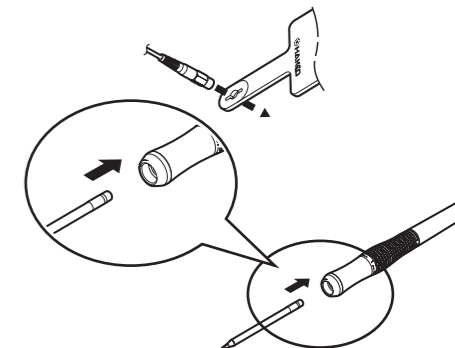

C. Station

CAUTION
Be sure the power switch is OFF before connecting or disconnecting the soldering iron cord. Failure to do so may result in damage to the circuit board.

- Insert the power cord into the receptacle at the back of the station.
- Insert the connection cable plug into the receptacle at the front of the station, and turn it in a clockwise direction until it stops.
- Set the iron in the iron holder.
- Plug the power cord into a grounded wall socket.

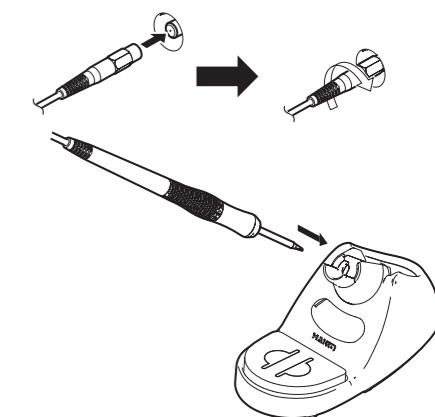

CAUTION
The HAKKO FX-100 is protected against electrostatic discharge and must be grounded for full efficiency.

中國RoHS: 產品中有毒有害物質或元素的名稱及含量

部件名稱	有毒有害物質或元素					
	鉛(Pb)	汞(Hg)	鎘(Cd)	六價鉻(Cr(VI))	多溴聯苯(PBB)	多溴二苯醚(PBDE)
焊鐵部	×	○	○	○	○	○
電路板	×	○	○	○	○	○
插頭	×	○	○	○	○	○

○: 表示該有毒有害物質在該部件所有均質材料中的含量均在SJ/T 11363-2006標準規定的限量要求以下。
×: 表示該有毒有害物質至少在該部件的某一均質材料中的含量超出SJ/T 11363-2006標準規定的限量要求。

5. OPERATION

● Operation

1. Turn ON the power switch.
2. The screen will switch in order of product number indication → greeting → home screen.
3. When the home screen is displayed, the MODE status is indicated on the left and output graph at the center. The graph starts rising as the iron tip temperature increases. The graph starts falling as the iron tip approaches stable temperature, reaching the minimum when the stable temperature is achieved. Start soldering after the stable temperature is reached.

Controls and displays

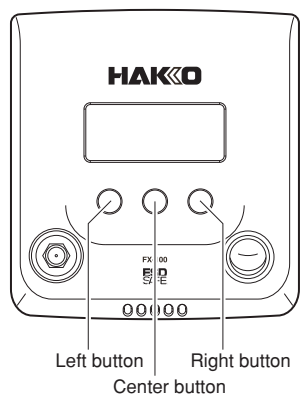

HAKKO FX-100 has 3 operation buttons. The operation executed by each button varies depending on what is on the display screen. The operation for each button is indicated at the bottom of the screen. Select the button according to the indication.

By pressing certain buttons from the home screen, the display will change, revealing the button labels and waiting for your selection.

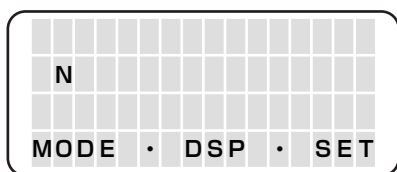

Left button MODE
Center button DSP (Display)
Right button SET (Parameters)

If no button is pressed, it will go back to the home screen.

Example) MODE screen

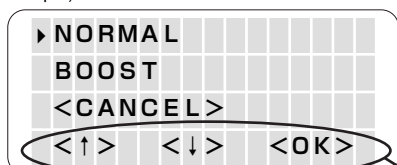

Operate the machine using these buttons that are placed in the order of the buttons displayed on the screen.

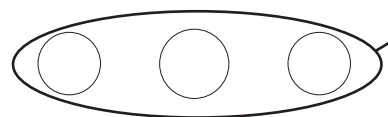

Display item and initial value of MODE / DSP screen are as follows.

Display	Display item	Initial value
MODE	NORMAL / BOOST	NORMAL
DSP	SHOW PROFILE / SHOW TIP LOADS / SHOW TIP TIME / SELECT PROFILE / TIP TYPE	
	SHOW PROFILE	Display in the set profile
	SHOW TIP LOADS	Display in the soldering count
	SHOW TIP TIME	Display in the cumulative running time on the iron tip
	SELECT PROFILE	No.1 / No.2
	TIP TYPE	AUTO DETECT / MANUAL SET / OFF
	MANUAL SET*	<01> / <02> / <03>

* Displayed only when "MANUAL SET" is selected.

● When MODE is pressed

The mode can be changed to NORMAL mode or BOOST mode. By changing the mode to BOOST, the performance of the station is increased and the tip temperature rises slightly.

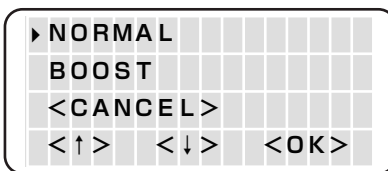

Move the cursor by pressing the <↑> or <↓> button to select NORMAL or BOOST. After selecting, press <OK>.

Display in the NORMAL mode

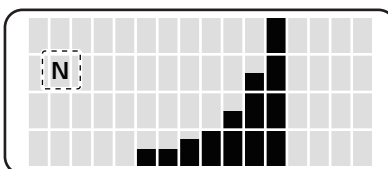

Display in the BOOST mode

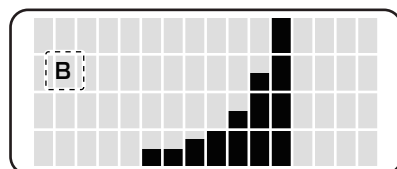

5. OPERATION

● When DSP (Display) is pressed

The selected information will be displayed on the screen.

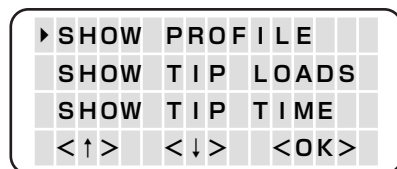

The cursor moves by pressing the <↑> or <↓> button. The following items are displayed in order.

- SHOW PROFILE
- SHOW TIP LOADS
- SHOW TIP TIME
- SELECT PROFILE
- TIP TYPE
- <CANCEL>

SHOW PROFILE

The set profile information (Station, User, and Solder) is displayed.

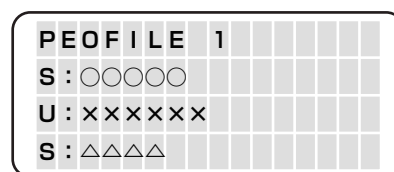
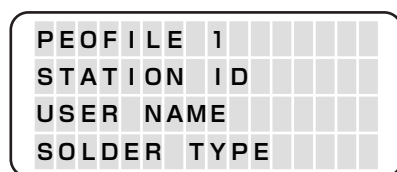

SHOW TIP LOADS

The soldering count is displayed. By selecting RESET and then OK, the count is reset to 0. To escape without resetting, select CANCEL.

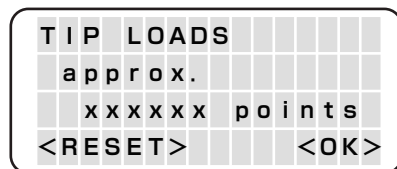

When RESET is selected

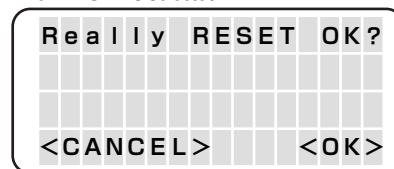

⚠ CAUTION

The solder count is an approximate number. The number is sometimes counted when temperature change occurs in the tip other than soldering.

SHOW TIP TIME

The cumulative running time on the iron tip is displayed. * Not including shut-off period. By selecting RESET and then OK, the period is reset to 0. To escape without resetting, select CANCEL.

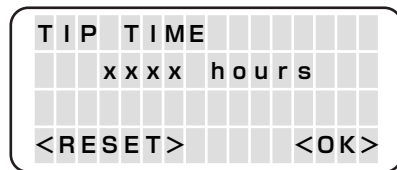

When RESET is selected

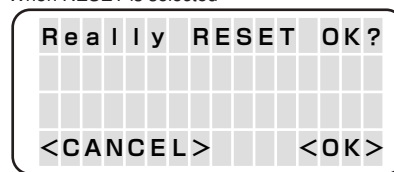

NOTE:

If you select RESET in the TIP LOADS screen or the TIP TIME screen, you need to enter the password if password lock is set.

SELECT PROFILE

The profile information to be displayed is selected here. Profile information No.1 or No.2 can be selected.

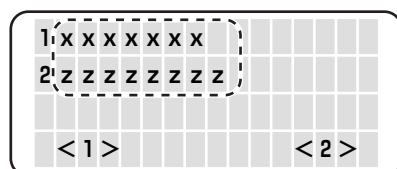

NOTE:

If any user name is set, it is displayed in this step.

5. OPERATION

TIP TYPE

The tip type (450° C or 400° C) is displayed. When MANUAL SET is selected, the screen changes to the one as shown in the lower right figure. Select an appropriate number according to the tip to be used. Then, the tip type 01 (450° C) or 02 (400° C) is displayed so that the tip type is clearly known.

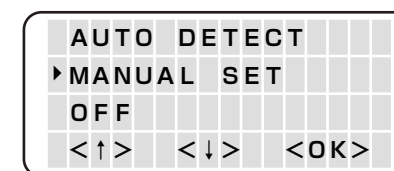

When MANUAL SET is selected

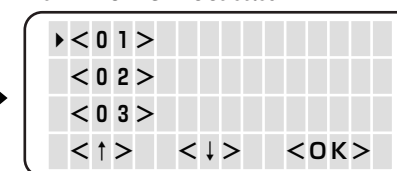

Display in the MANUAL SET mode (when T31-01 is selected)

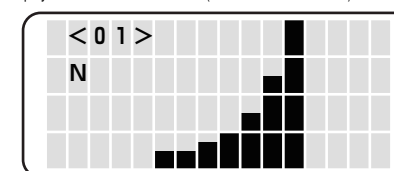

When AUTO DETECT is selected, the tip type (type 01 (450° C) or type 02 (400° C)) is automatically detected. The following conditions are required to detect the tip type.

- The tip must be cold.
- The tip must be placed on the soldering iron stand.

Display in the AUTO DETECT mode (when T31-01 is selected)

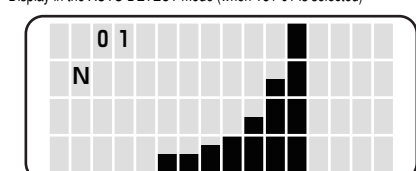

When the tip is frequently changed between type 01 and type 02, you can select AUTO DETECT. When you do not need automatic detection because you use either type only, you can select MANUAL SET. When you do not need any display, you can select OFF. You can select any mode depending on the usage.

NOTE:

When AUTO DETECT is selected, 01 or 02 is displayed only when the soldering iron is placed on the stand.

6. PARAMETER SETTING

● When SET is pressed

Various settings can be changed. After changing the setting, setting change is reflected by selecting SAVE → OK. To escape without setting change, select CANCEL. パスワードロックの設定を行なっている場合、SET画面へ移行する前にパスワードの入力が必要となります。

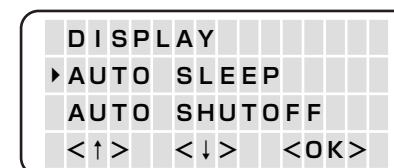

The cursor moves by pressing the <↑> or <↓> button. The following items are displayed in order.

- DISPLAY
- AUTO SLEEP
- AUTO SHUTOFF
- PASSWORD LOCK
- PROFILE
- ALERT TIME
- <SAVE>
- <CANCEL>

Display item and initial value of SET screen are as follows.

Display	Display item	Initial value
SET	DISPLAY / AUTO SLEEP / AUTO SHUT OFF / PASSWORD LOCK / PROFILE / ALERT TIME	
	DISPLAY	NORMAL / EXPAND / OFF
	AUTO SLEEP	00 (OFF) / 01 - 29 min
	AUTO SHUT OFF	OFF / 30 min / 60 min
	PASSWORD LOCK	ON / OFF
	PASSWORD*	"A - Z" Select three letters
	PROFILE	STATION ID / PROFILE 1 / PROFILE 2
	STATION ID	"A - Z", "0 - 9", ".", "-" and space. You can enter up to 14 letters.
	PROFILE 1 (2)	USER NAME / SOLDER TYPE
	USER NAME	"A - Z", "0 - 9", ".", "-" and space. You can enter up to 14 letters.
	SOLDER TYPE	"A - Z", "0 - 9", ".", "-" and space. You can enter up to 14 letters.
	ALERT TIME**	0 - 9999 hours

* Displayed only when PASSWORD LOCK "ON" is selected.

** CHG TIP will not be displayed when ALERT TIME is set to "0". (See the "ALERT TIME")

6. PARAMETER SETTING

DISPLAY

The fashion in which the output graph is displayed can be changed.
 NORMAL: Histogram (rolling bar graph), EXPAND: Horizontal expanding graph, OFF: No display

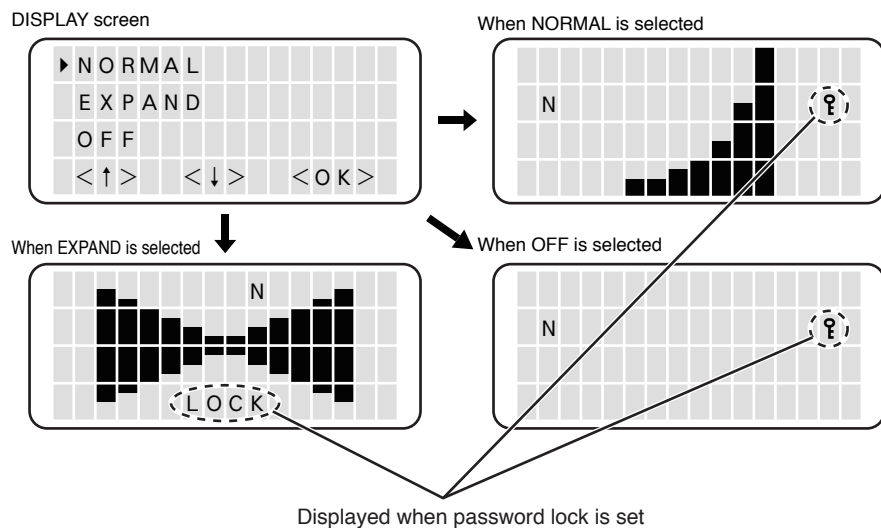

AUTO SLEEP

The automatic sleep period can be set up. Sleep function is canceled by removing the solder iron from the holder or pressing one of the 3 buttons.

Setting AUTO SLEEP

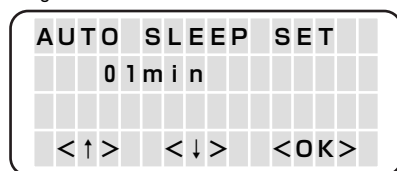

In the AUTO SLEEP mode, you can set the sleep time between 01 to 29 minutes. When 00 is set, the sleep function is OFF

AUTO SHUTOFF

The time to automatically turn off the soldering station can be set up. Electricity is stopped automatically when the solder iron is not used for the set period of time. SHUTOFF function is canceled by pressing one of the 3 buttons.

Setting AUTO SHUTOFF

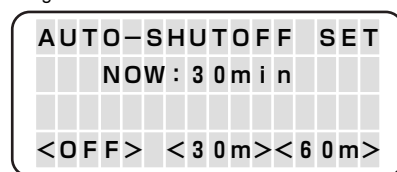

When the SHUT OFF time is set, the power supply stops when the soldering iron is not used for the set period of time even though the soldering iron is not placed on the stand.

PASSWORD LOCK

The setting can be changed so that a password input is required every time a parameter is changed or a count is reset. A 3-letter password comprising of letters A to Z is set up.

Setting PASSWORD LOCK

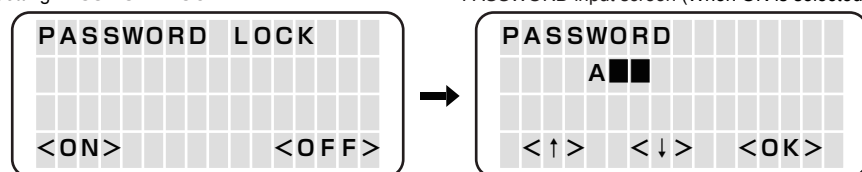

6. PARAMETER SETTING

PROFILE

The profile information can be set up.
 STATION ID: Station name, Asset ID, etc., PROFILE1,2: User name and solder information.

PROFILE screen

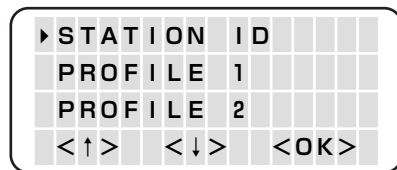

When STATION ID is selected

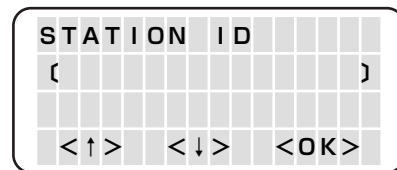

When PROFILE1 (2) is selected

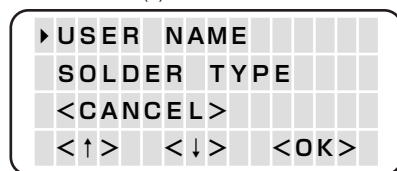

When USER NAME is selected

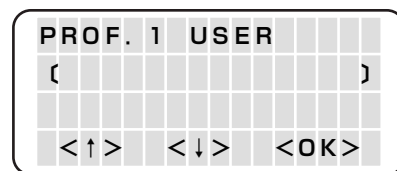

When SOLDER TYPE is selected

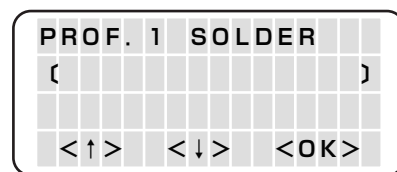

You can make your name and ID from "A-Z", "0-9", ".", "-", and space. You can enter up to 14 letters. This is blank in the initial setting.

ALERT TIME

"CHG TIP" is displayed on the home screen when the iron tip cumulative running time reaches the set period. To clear this display, you need to change the tip and reset the TIP TIME from the DSP menu. (See 5. How to Use, "SHOW TIP TIME".)

Setting ALERT TIME

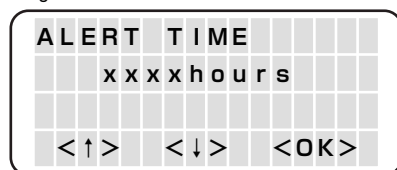

Display in the "CHG TIP"

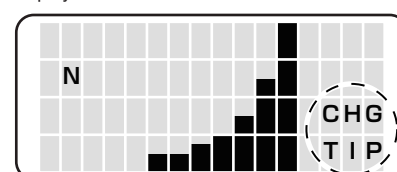

7. MAINTENANCE

Performing proper and periodic maintenance extends product life. Efficient soldering depends upon the temperature, quality and quantity of the solder and flux. Apply the following service procedure as dictated by the conditions of usage.

WARNING

Since the soldering iron can reach a very high temperature, please work carefully. Except the case especially indicated, always turn the power switch OFF and disconnect the power plug before performing any maintenance procedure.

Tip Maintenance

- When the temperature stabilizes, clean the tip with the cleaning sponge and check the condition of the tip.
- If the solder plated part of the tip is covered with black oxide, apply fresh solder containing flux, and clean the tip again. Repeat until all the oxide is removed, then coat the tip with fresh solder.
- If the tip is deformed or heavily eroded, replace it with a new one.

CAUTION

Do not file the tip in an attempt to remove the black oxide.

Cleaning the tip using the iron holder

- Using the cleaning sponge

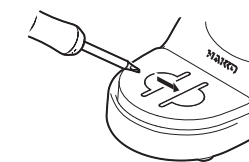

Use the cleaning sponge that comes with the product to clean the tip. It offers wide-ranging uses, from simple removal of excess solder to complete elimination of matter occurring as a result of oxidation.

- Using the cleaning wire

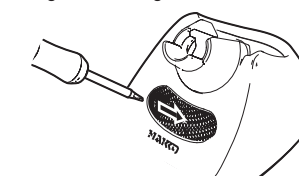

Material that is not removed easily with the cleaning sponge can likely be removed using the cleaning wire.

Replacing the fuse

- Unplug the power cord from the power receptacle.
- Remove the fuse holder.
- Replace the fuse.
- Put the fuse holder back in place.

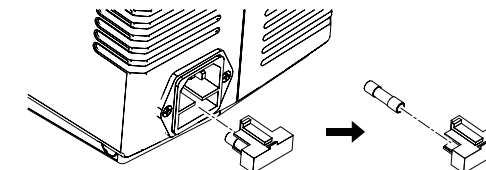

8. TROUBLE SHOOTING GUIDE

WARNING

Before checking the inside of the HAKKO FX-100 or replacing parts, be sure to disconnect the power plug. Failure to do so may result in electric shock.

- The solder iron does not operate even when the power switch is turned ON.

CHECK : Is the power supply cable or connection plug disconnected?
ACTION : Connect it tightly.

CHECK : Is the fuse blown?
ACTION : Replace the fuse. If the fuse blows again, please send the entire product back to us for repair.

- Grip Error is displayed.

ACTION : Check that the soldering iron or the iron tip is connected. If the error is displayed again even when it is connected, the soldering iron or the iron tip may be damaged.

- Solder does not become wet at the iron tip.

CHECK : Is the tip oxidized?
ACTION : Clean the tip to remove oxidation.

- The tip temperature is too Low.

CHECK : Is the tip oxidized?
ACTION : Clean the tip to remove oxidation.

9. OPTION

The port on the back of the station is used to display heater output on the external device. (not included)

The output displayed on the monitor can be displayed on an external device by connecting the machine to equipment such as an oscilloscope.

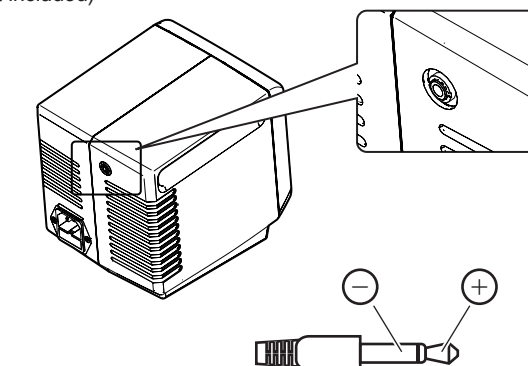

Please purchase in the way of your connection plug (Φ3.5 mono plug).

10. PARTS LIST

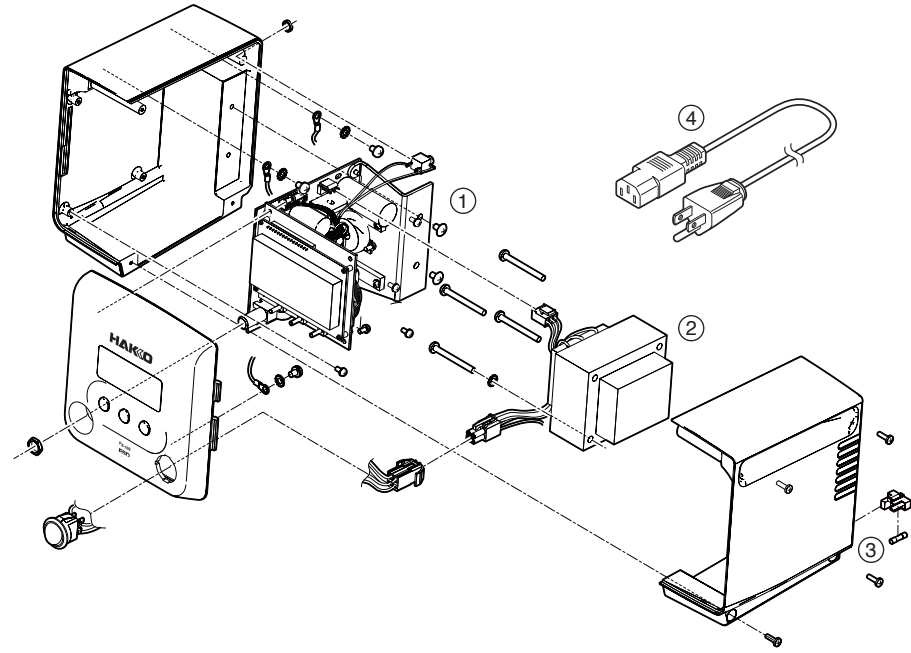

● HAKKO FX-100 Starion

Item No.	Part No.	Part Name	Specifications
①	B5002	P.W.B	
	B5003	Transformer	100 - 110V
②	B5004	Transformer	120V
	B5005	Transformer	220 - 240V
③	B2403	Fuse/250V-2A	100 - 110V
	B3011	Fuse/250V-2A	120V
	B2987	Fuse/250V-1A	220 - 240V

Item No.	Part No.	Part Name	Specifications
④	B2419	Power cord, 3-wire cord & American plug	120V USA
	B2421	Power cord, 3-wire cord but no plug	
	B2422	Power cord, 3-wire cord & BS plug	India
	B2424	Power cord, 3-wire cord & European plug	220V KTL 230V CE
	B2425	Power cord, 3-wire cord & BS plug	230V CE
	B2426	Power cord, 3-wire cord & Australian plug	
	B2436	Power cord, 3-wire cord & Chinese plug	China
	B3508	Power cord, 3-wire cord & American plug (B)	
	B3550	Power cord, 3-wire cord & SI plug	

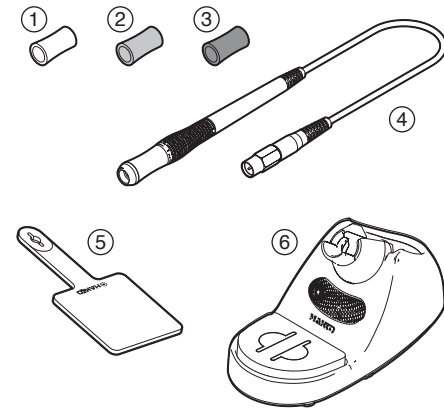

● HAKKO FX-1001

Item No.	Part No.	Part Name	Specifications
①	B5006	Sleeve / Yellow	
②	B5007	Sleeve / Green	
③	B5008	Sleeve / Gray	
④	FX1001-81	HAKKO FX-1001	
⑤	B2300	Heat resistand pad	
⑥	FH800-81BY	HAKKO FH-800	

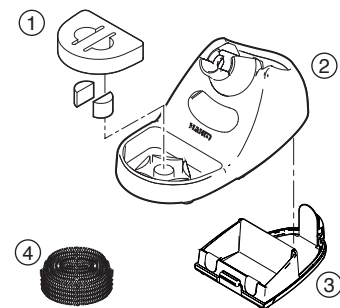

● Iron Holder Parts

Item No.	Part No.	Part Name	Specifications
①	A1559	Cleaning sponge	
②	B5009	Iron holder base / Blue-yellow	with rubber foot
③	B3751	Bottom plate	with Protective Sheet & rubber foot
④	A1561	Cleaning wire	

● Optional Parts

Part No.	Part Name	Specifications
B3474	Rubber cleaner	