



Dimension			
L	W	H	
325.8	107	41 (1U)	mm
12.8	4.21	1.61(1U)	inch



**■ Features**

- Charger for lead-acid batteries (Gel, flooded and AGM) and Li-ion batteries (lithium iron and lithium manganese)
- Built-in default 3 stage charging curves and programmable curve
- Built-in I<sup>2</sup>C interface, PMBus protocol (Optional CANBus protocol)
- Universal AC input / Full range
- Built-in active PFC function
- Forced air cooling by built-in thermal controlled DC fans
- Output voltage and current programmable
- Built-in OR-ing FET
- Active current sharing up to 6400W(1+1)
- Protections: Battery under voltage / Battery no connection / Short circuit / Over voltage / Over temperature
- Optional conformal coating
- 5 years warranty

**■ Certificates**

- Safety: UL/EN/IEC 62368-1
- EMC: EN 55032 / 55024

**■ Applications**

- Large scale DC UPS or emergency backup system
- Marine battery charger module
- Electric scooter or vehicle charger station
- Wastewater treatment system
- Electrolysis system

**■ Description**

DBU-3200 is a 3200W single output AC/DC enclosed charger in 1U low profile with high power density, 37W/inch<sup>3</sup>. It is an intelligent charger that has pre-loaded programmable charging curves for different types of lead-acid and li-ion batteries. Output programmable function allows user to adjust the charging voltage and current via the built-in potentiometer or PMBus protocol. Various protection mechanisms as well as the temperature compensation function are provided to assure normal and safe system operation.

**■ Model Encoding / Order Information**

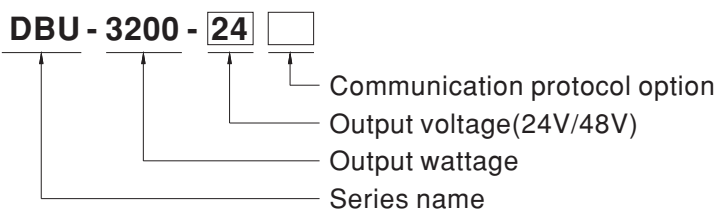

Type	Communication Protocol	Note
Blank	PMBus protocol	In Stock
CAN	CANBus protocol	By request



**SPECIFICATION**

MODEL		DBU-3200-24	DBU-3200-48	
OUTPUT	BOOST CHARGE VOLTAGE(Vboost)(default)	28.8V	57.6V	
	FLOAT CHARGE VOLTAGE(Vfloat)(default)	27.6V	55.2V	
	CONSTANT CURRENT(CC)(default)	110A	55A	
	VOLTAGE ADJ. RANGE	By built-in potentiometer, SVR		
		23.5 ~ 30V	47.5 ~ 58.8V	
	RECOMMENDED BATTERY CAPACITY(AMP HOURS) Note.3	330 ~ 1000Ah	180 ~ 550Ah	
LEAKAGE CURRENT FROM BATTERY (Typ.)	1.5mA			
INPUT	VOLTAGE RANGE Note.4	90 ~ 264VAC 127 ~ 370VDC		
	FREQUENCY RANGE	47 ~ 63Hz		
	POWER FACTOR (Typ.)	0.97/230VAC at full load		
	EFFICIENCY (Typ.)	93.5%	94.5%	
	AC CURRENT (Typ.) Note.4	17A/230VAC		
	INRUSH CURRENT (Typ.)	COLD START 55A/230VAC		
	LEAKAGE CURRENT	<2mA / 230VAC		
PROTECTION	OVER VOLTAGE	31.5 ~ 37.5V	63 ~ 75V	
		Protection type : Shut down o/p voltage, re-power on to recover		
	OVER TEMPERATURE	Shut down o/p voltage, recovers automatically after temperature goes down		
FUNCTION	OUTPUT VOLTAGE PROGRAMMABLE(PV)	Adjustment of output voltage is allowable to 75 ~ 125% of nominal output voltage. Please refer to the Function Manual.		
	OUTPUT CURRENT PROGRAMMABLE(PC)	Adjustment of output voltage is allowable to 20 ~ 100% of rated current. Please refer to the Function Manual.		
	AUXILIARY POWER	5V @ 0.3A, tolerance ±10%, ripple 150mVp-p, 12V @ 0.8A, tolerance ±10%, ripple 450mVp-p		
	REMOTE ON-OFF CONTROL	By electrical signal or dry contact Power ON:short Power OFF:open. Please refer to the Function Manual		
	TEMPERATURE COMPENSATION	-3mV / °C / cell / (12V = 6 cells ; 24V = 12 cells ; 48V = 24 cells)		
	ALARM SIGNAL	Isolated signal output for T-alarm and DC-OK		
ENVIRONMENT	WORKING TEMP.	-30 ~ +70°C (Refer to "Derating Curve")		
	WORKING HUMIDITY	20 ~ 90% RH non-condensing		
	STORAGE TEMP., HUMIDITY	-40 ~ +85°C, 10 ~ 95% RH non-condensing		
	TEMP. COEFFICIENT	±0.03%/°C (0 ~ 50°C)		
	VIBRATION	10 ~ 500Hz, 2G 10min./1cycle, 60min. each along X, Y, Z axes		
SAFETY & EMC (Note 6)	SAFETY STANDARDS	UL62368-1, TUV EN62368-1, EAC TP TC 004 approved		
	WITHSTAND VOLTAGE	I/P-O/P:3KVAC I/P-FG:2KVAC O/P-FG:1.5KVAC		
	ISOLATION RESISTANCE	I/P-O/P, I/P-FG, O/P-FG:100M Ohms / 500VDC / 25°C / 70% RH		
	EMC EMISSION	Parameter	Standard	Test Level / Note
		Conducted	EN55032 (CISPR32) / EN55011 (CISPR11)	Class B
		Radiated	EN55032 (CISPR32) / EN55011 (CISPR11)	Class A
		Harmonic Current	EN61000-3-2	-----
		Voltage Flicker	EN61000-3-3	-----
	EMC IMMUNITY	EN55024, EN61204-3, EN61000-6-2		
		Parameter	Standard	Test Level / Note
		ESD	EN61000-4-2	Level 3, 8KV air ; Level 2, 4KV contact
		Radiated	EN61000-4-3	Level 3
		EFT / Burst	EN61000-4-4	Level 3
		Surge	EN61000-6-2	2KV/Line-Line 4KV/Line-Earth
		Conducted	EN61000-4-6	Level 3
Magnetic Field		EN61000-4-8	Level 4	
Voltage Dips and Interruptions		EN61000-4-11	>95% dip 0.5 periods, 30% dip 25 periods, >95% interruptions 250 periods	
OTHERS	MTBF	160.1K hrs min. Telcordia SR-332 (Bellcore) ; 38.9K hrs min. MIL-HDBK-217F (25°C)		
	DIMENSION	325.8*107*41mm (L*W*H)		
	PACKING	2.76Kg;4pcs/12Kg/0.83CUFT		
NOTE	<p>1. Modification for charger specification may be required for different battery specification. Please contact battery vendor and MEAN WELL for details.</p> <p>2. All parameters NOT specially mentioned are measured at 230VAC input, rated load and 25°C of ambient temperature.</p> <p>3. This is MEAN WELL's suggested range. Please consult your battery manufacturer for their suggestions about maximum charging current limitation.</p> <p>4. Derating may be needed under low input voltages. Please check the derating curve for more details.</p> <p>5. The charger is considered a component which will be installed into a final equipment. All the EMC tests are been executed by mounting the unit on a 600mm*900mm metal plate with 1mm of thickness. The final equipment must be re-confirmed that it still meets EMC directives. For guidance on how to perform these EMC tests, please refer to "EMI testing of component power supplies." (as available on <a href="http://www.meanwell.com">http://www.meanwell.com</a>)</p> <p>6. The ambient temperature derating of 3.5°C/1000m with fanless models and of 5°C/1000m with fan models for operating altitude higher than 2000m(6500ft).</p>			

**■ BLOCK DIAGRAM**

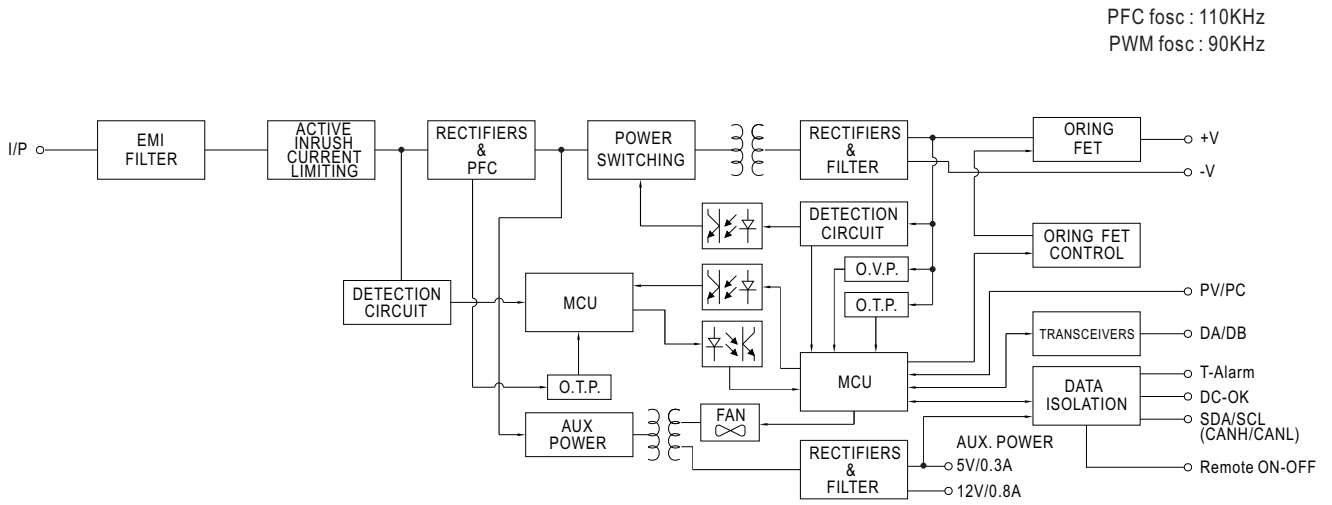

**■ DERATING CURVE**

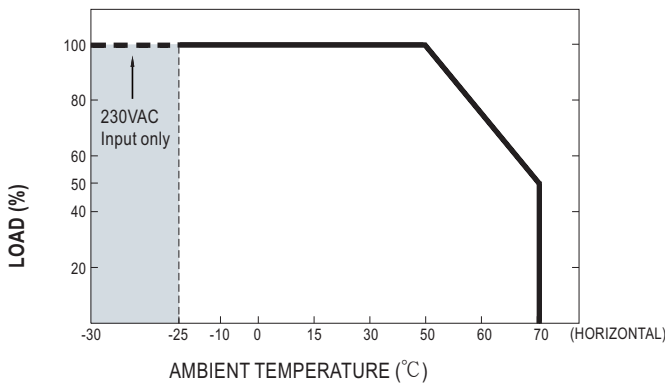

**■ STATIC CHARACTERISTICS**

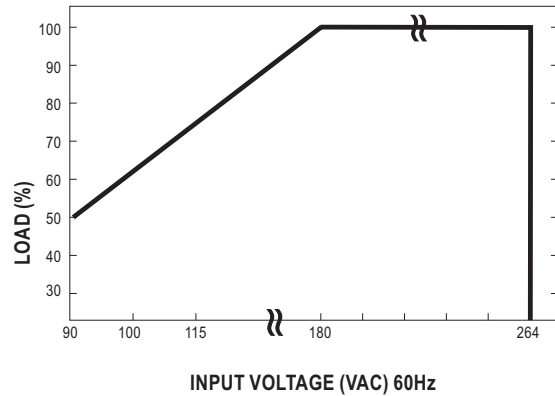

**FUNCTION MANUAL**

**1. PMBus Communication Interface**

DBU-3200 supports PMBus Rev. 1.1 with maximum 100KHz bus speed, allowing information reading, status monitoring, output trimming, etc. For details, please refer to the Installation Manual.

**2. Charging Curve**

- ※ By factory default, this charger performs the default curve which can be programmed via PMBus.
- ※ To disable / enable the charging curve, change to a 2 stage curve, a different curve frequently used for certain types of batteries in the industry, and so on, please refer to the Installation Manual.
- ※ To program the parameters of the charging curve, SBP-001, the smart battery charging programmer designed by MEAN WELL, and a personal computer are needed. Please contact MEAN WELL for details.

⊙ Default 3 stage charging curve

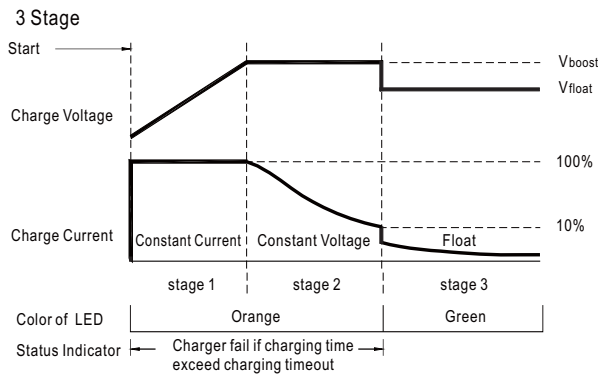

⊙ Embedded 3 stage charging curves

MODEL	Description	Vboost	Vfloat	CC(default)
24V	Default, programmable	28.8	27.6	110A
	Pre-defined, gel batter	28	27.2	
	Pre-defined, flooded battery	28.4	26.8	
	Pre-defined, AGM battery	29	27	
48V	Default, programmable	57.6	55.2	55A
	Pre-defined, gel batter	56	54.4	
	Pre-defined, flooded battery	56.8	53.6	
	Pre-defined, AGM battery	58	54	

Note:

When using this charger unit, please configured the system with recommended battery capacity defined by specification . Should battery capacity in use be much smaller so that user needs to set a low current for charging, under such condition it might cause higher current ripple.

⊙ Suitable for lead-acid batteries (flooded, Gel and AGM) and Li-ion batteries (lithium iron and lithium manganese).

**3. Front Panel LED Indicators & Corresponding Signal at Function Pins**

LED	Description
● Green	Float (stage 3)
● Orange	Charging (stage 1 or stage 2)
● Red	The LED will present a constant red light when the abnormal status (OTP, OLP, fan fail and charging timeout) arises.
● Red (Flashing)	The LED will flash with the red light when the internal temperature reaches 60°C; under this condition, the unit still operates normally without entering OTP. (In the meantime, an alarm signal will be sent out through the PMBus interface.)

**4. Output Voltage Programming (or, PV / remote voltage programming / remote adjust / margin programming / dynamic voltage trim)**

※ In addition to the adjustment via the built-in potentiometer, the output voltage can be trimmed by applying EXTERNAL VOLTAGE.

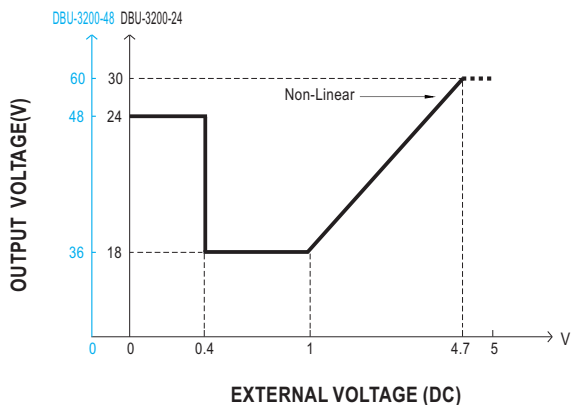
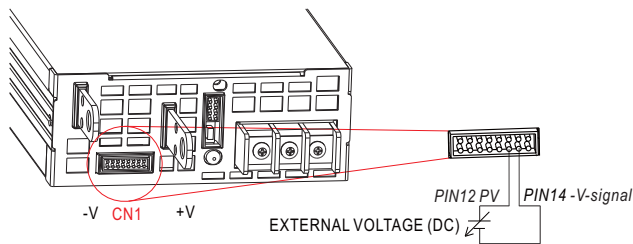

**5. Output Current Programming (or, PC / remote current programming / dynamic current trim)**

※ The output current can be trimmed to 20~100% of the rated current by applying EXTERNAL VOLTAGE.

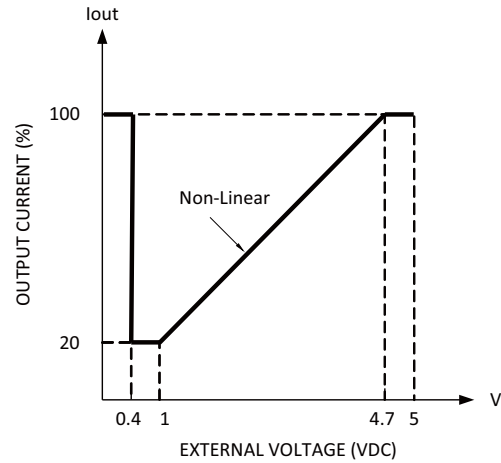
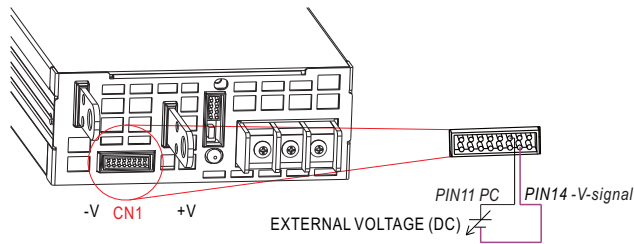

**6. Remote ON-OFF Control**

The power supply can be turned ON/OFF individually or along with other units in parallel by using the "Remote ON-OFF" function.

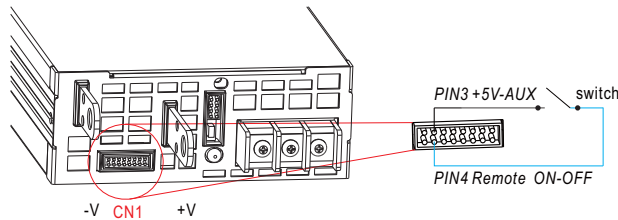

Between Remote ON-OFF and +5V-AUX	Power Supply Status
Switch Short	ON
Switch Open	OFF

**7. Temperature Compensation**

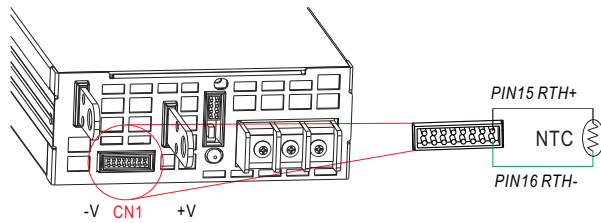

- ◎ To exploit the temperature compensation function, please attach the temperature sensor, NTC, which is enclosed with the charger, to the battery or the battery's vicinity.
- ◎ The charger is able to work normally without the NTC.

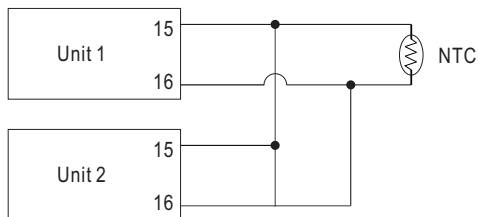

When multiple chargers are connected in parallel, please configure with the NTC as exhibited in the diagram .  
If the temperature compensation is not required, RTH+ (PIN15) and RTH- (PIN16) from each unit still need to be connected.

**8. Alarm Signal Output**

※ There are 2 alarm signals, DC OK and T-ALARM, in TTL signal form, on CN1. These signals are isolated from output. The maximum sink current is 10mA.

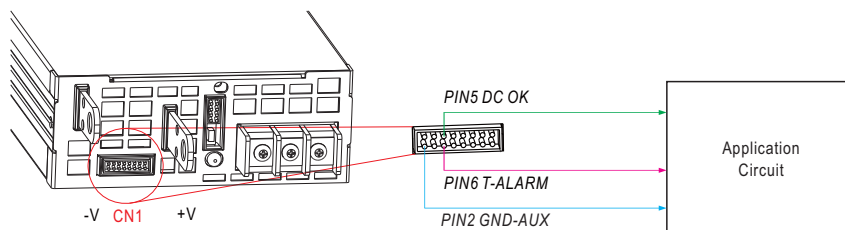

**9. Current Sharing with Remote Sensing**

DBU-3200 has the built-in active current sharing function and can be connected in parallel, up to 2 units, to provide higher output power as exhibited below :

- ※ The power supplies to be paralleled should use short and large diameter wiring and then connected to the load.
- ※ Difference of output voltages among parallel units should be less than 0.2V.
- ※ The total output current must not exceed the value calculated by the following equation:  

$$\text{Maximum output current at parallel operation} = (\text{Rated current per unit}) \times (\text{Number of unit}) \times 0.9$$
- ※ When the total output current is less than 5% of the total rated current, or say  $(5\% \text{ of Rated current per unit}) \times (\text{Number of unit})$  the current shared among units may not be balanced.
- ※ CN500/SW1 Function pin connection

Parallel	PSU1		PSU2	
	CN500	SW1	CN500	SW1
1 unit	X	ON	—	—
2 unit	V	ON	V	ON

(V : CN500 connected ; X : CN500 not connected.)

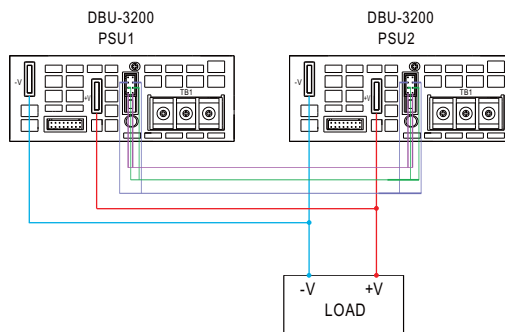
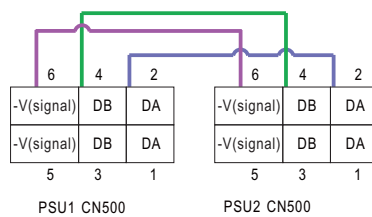

Fig 5.1



↑  
If the lines of CN500 are too long, they should be twisted in pairs to avoid the noise.

◎ DA, DB and -V(signal) are connected mutually in parallel.

MECHANICAL SPECIFICATION

Case No.256 Unit:mm

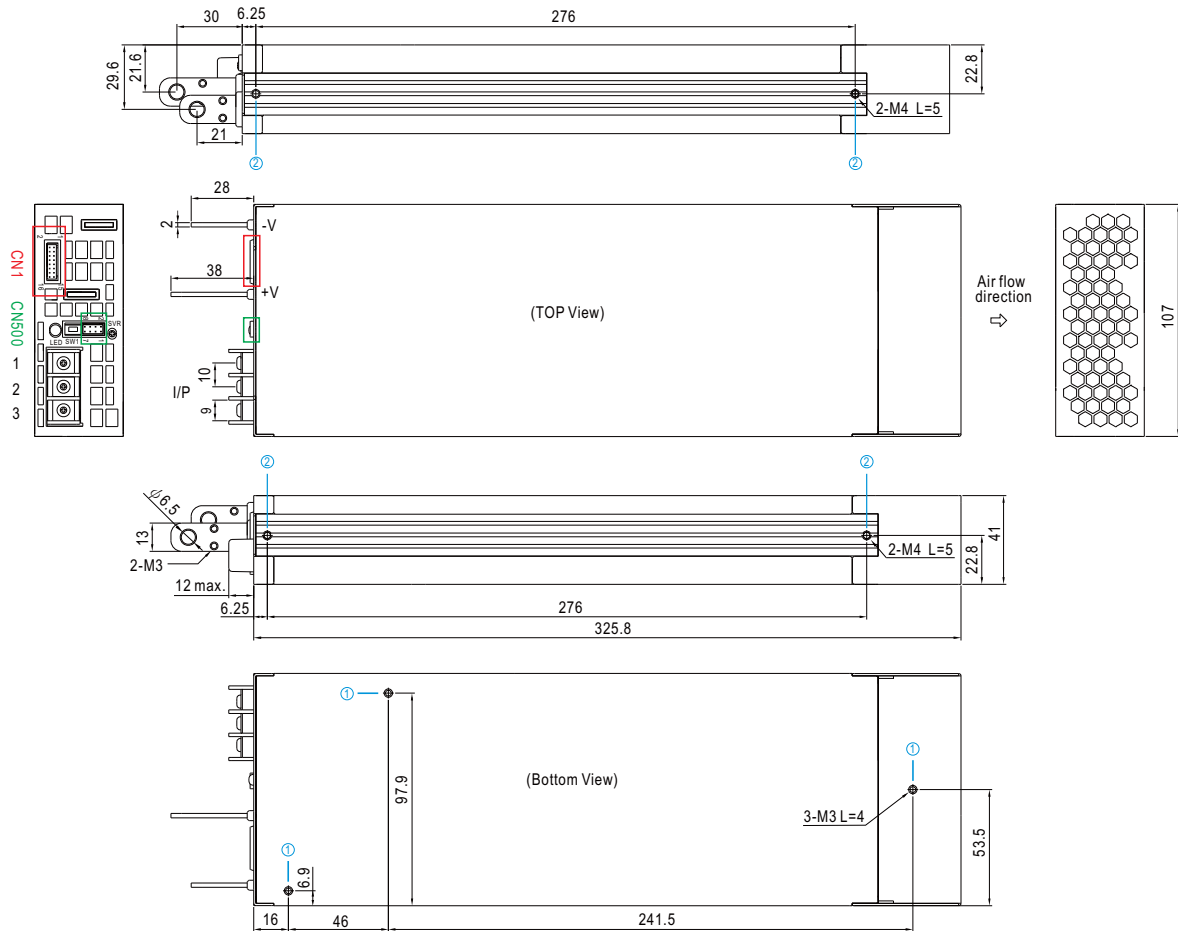

※ Mounting Instruction

Hole No.	Recommended Screw Size	MAX. Penetration Depth L	Recommended mounting torque
①	M3	6mm	6~8Kgf-cm
②	M4	7mm	7~10Kgf-cm

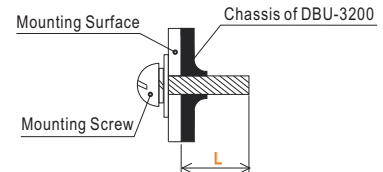

※Control Pin No. Assignment(CN1) : HRS DF11-16DP-2DS or equivalent

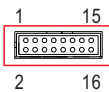

Mating Housing	HRS DF11-16DS or equivalent
Terminal	HRS DF11-16SC or equivalent

Pin No.	Function	Description
1	+12V-AUX	Auxiliary voltage output, 10.6~13.2V, referenced to GND-AUX (pin2). The maximum load current is 0.8A. This output has the built-in "Oring diodes" and is not controlled by "Remote ON-OFF".
2	GND-AUX	Auxiliary voltage output GND. The signal return is isolated from the output terminals (+V & -V).
3	+5V-AUX	Auxiliary voltage output, 4.5~5.5V, referenced to GND-AUX (pin2). The maximum load current is 0.3A. This output has the built-in "Oring diodes" and is not controlled by "Remote ON-OFF".
4	Remote ON-OFF	The unit can turn the output ON/OFF by electrical signal or dry contact between <i>Remote ON/OFF</i> and +5V-AUX. (Note.2) Short (4.5 ~ 5.5V) : Power ON ; Open (-0.1 ~ 0.5V) : Power OFF ; The maximum input voltage is 5.5V.
5	DC-OK	High (4.5 ~ 5.5V) : When the $V_{out} \leq 16V/32V \pm 1V$ . Low (-0.1 ~ 0.5V) : When $V_{out} \geq 16V/32V \pm 1V$ . The maximum sourcing current is 10mA and only for output. (Note.2) DC OK is associated with battery low protection.
6	T-ALARM	High (4.5 ~ 5.5V) : When the internal temperature exceeds the limit of temperature alarm, or when Fan fails. Low (-0.1 ~ 0.5V) : When the internal temperature is normal, and when Fan works normally. The maximum sourcing current is 10mA and only for output.(Note.2)
7,8,9	A0,A1,A2	PMBus interface address lines. (Note.1)
10	D0	DIP-switch interface lines for charging curve selection. (Note.1)
11	PC	Connection for output current programming. (Note.1)
12	PV	Connection for output voltage programming. (Note.1)
13	+V (Signal)	Positive output voltage signal. It cannot be connected directly to the load.
14	-V (Signal)	Negative output voltage signal. It is for certain function reference; it cannot be connected directly to the load.
15	RTH+	Temperature sensor(NTC, 5KOhm) comes along with the charger can be connected to the unit to allow temperature compensation of the charging voltage.
16	RTH-	

Note1: Non-isolated signal, referenced to the [-V(signal)].

Note2: Isolated signal, referenced to GND-AUX.

※AC Input Terminal Pin No. Assignment

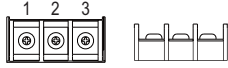
Pin No.	Assignment	Diagram	Maximum mounting torque
1	FG $\perp$		8Kgf-cm
2	AC/N		
3	AC/L		

※Control Pin No. Assignment(CN500) : HRS DF11-8DP-2DS or equivalent

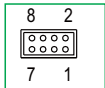

Mating Housing	HRS DF11-8DS or equivalent
Terminal	HRS DF11-**SC or equivalent

Pin No.	Function	Description
1, 2	DA	Differential digital signal for parallel control.
3, 4	DB	Differential digital signal for parallel control.
5, 6	-V (Signal)	Negative output voltage signal. It is for local sense; and certain function reference; it cannot be connected directly to the load.
7	SDA	Serial clock used in the PMBus interface.
8	SCL	Serial clock used in the PMBus interface.

※Control Pin No. Assignment.(SW1)

Pin No.	Function	Description
1, 2	Terminal resistance	SW1 is the selector of terminal resistor that is designed for DA/DB signals and parallel control function.

■ INSTALLATION MANUAL

Please refer to : <http://www.meanwell.com/manual.html>