



FEATURE

1. Sealed construction - internal actuator o-ring and epoxy terminal seal standard
2. Carry the IP67 approvals
3. The ESD protection available - Anti-static plastic actuator -9000 V DC static resistance between toggle and terminal.

SPECIFICATIONS

CONTACT RATING:R- 0.4 VA max @ 20 V AC or DC
 ELECTRICAL LIFE:30,000 make-and-break cycles at full load
 CONTACT RESISTANCE: 20 mΩ max. initial @2-4 VDC,100 mA
 INSULATION RESISTANCE: 1,000 MΩ min.
 DIELECTRIC STRENGTH: 1,500 V RMS @ sea level.

ESD Resistant Option :

P2 insulating actuator only:9,000 VDC min. @ sea level,actuator to terminals.

DEGREE OF PROTECTION : IP67

OPERATING TEMPERATURE: -30°C to +85°C

MATERIALS

CASE and BUSHING - glass filled nylon 6/6,flame retardant heat stabilized (UL94V-0)

Actuator - Copper alloy , chrome plated,internal o-ring seal standard with all actuators

P2 / the anti-static actuator: Nylon 4/6,black standard(UL 94V-0)

CONTACT AND TERMINAL - Brass , silver plated

SWITCH SUPPORT - Brass , tin-plated

TERMINAL SEAL - Epoxy

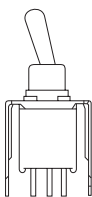
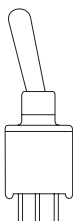
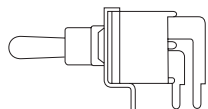

IP 67 protection degree

How do you build the switches you need!!

The ES-4 / ES-5 , please see the (A) ;

The ES-6/ES-7/ES-8/ES-9, please see the (B)

(A) **E S - 4 - P 2 C R - A 5 -**

Switch Function		Actuator		Termination	Contact Material	Vertical support Bracket	RoHS code
ES-4	SP on-none-on	T1	Std. 10.16 <input type="checkbox"/>	C (std) P.C	Q silver plated	(none) A5 straight type A5S (std.) snap-in type	<input type="checkbox"/> = none H = RoHS Compliant
ES-4B	SP on-none-(on)	T2	Std. 6.10		R gold plated		
ES-4A	SP on-off-on	T3	8.13	G gold over silver			
ES-4H	SP (on)-off-(on)	T4	13.97	K gold / tin			
ES-4I	SP on-off-(on)	T5	3.5				
ES-5	DP on-none-on	ESD protection actuator					
ES-5B	DP on-none-(on)	P1	(black) 10.16 <input type="checkbox"/>				
ES-5A	DP on-off-on	P11	(white) 10.16 <input type="checkbox"/>				
ES-5H	DP (on)-off-(on)	P2	(std - black) 6.10				
ES-5I <input type="checkbox"/>	DP on-off-(on) <input type="checkbox"/>	P21	(white) 6.10				
ES-5C	DP on-on-on						

(B) **E S - 6 - T 2 R - S -**

Horizon Right Angle	Vertical Right Angle	Switches Function	Actuator	Contact Material	Support Bracket <input type="checkbox"/> type	RoHS code
ES-6	ES-8	SP on-none-on	T1 10.16 <input type="checkbox"/>	Q silver plated	S (std.) Snap-in type (none) straight type	<input type="checkbox"/> = none H = RoHS Compliant
ES-6B		ES-8B	SP on-none-(on)	T2 Std. 6.10		
ES-6A	ES-8A	SP on-off-on	T3 8.13	G gold over silver		
ES-6H	ES-8H	SP (on)-off-(on)	T4 13.97	K gold / tin		
ES-6I	ES-8I	SP on-off-(on)	T5 3.5			
ES-7	ES-9	DP on-none-on	ESD protection actuator			
ES-7B	ES-9B	DP on-none-(on)	P1 (black) 10.16 <input type="checkbox"/>			
ES-7A	ES-9A	DP on-off-on	P11 (white) 10.16 <input type="checkbox"/>			
ES-7H	ES-9H	DP (on)-off-(on)	P2 (std - black) 6.10			
ES-7I <input type="checkbox"/>	ES-9I <input type="checkbox"/>	DP on-off-(on) <input type="checkbox"/>	P21 (white) 6.10			
ES-7C	ES-9C	DP on-on-on				

INDEX TOGGLE

ROCKER

SLIDE

PUSHBUTTON

DIP

TACT



SPDT



Model No.	Switching position		
ES-4	ON	none	ON
ES-4A	ON	OFF	ON
ES-4B	ON	None	(ON)
ES-4H	(ON)	OFF	(ON)
ES-4I	ON	OFF	(ON)
Term. Comm.	2-3	open	2-1

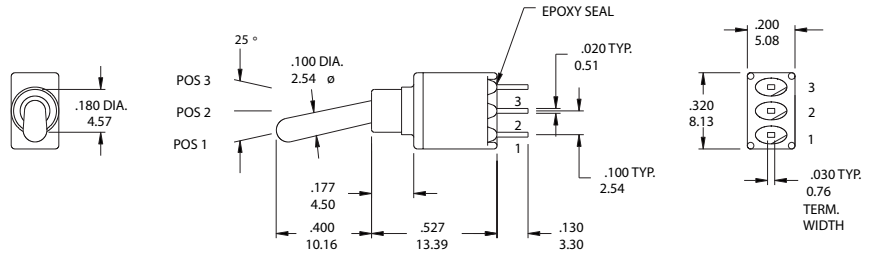
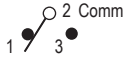

ES-4- T1CR

DPDT

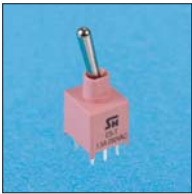

Model No.	Switching position		
ES-5	ON	none	ON
ES-5A	ON	OFF	ON
ES-5B	ON	None	(ON)
ES-5H	(ON)	OFF	(ON)
ES-5I	ON	OFF	(ON)
Term. Comm.	2-3,5-6	open	2-1,5-4
3 way switches (SP3T)			
ES-5C	ON	ON	ON
Term. Comm.	2-3,5-6	2-3,5-4	2-1,5-4

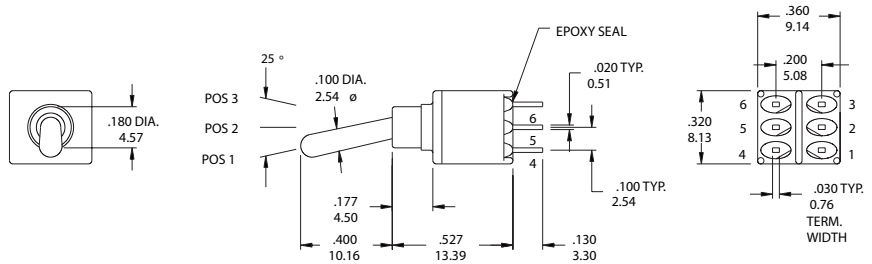

ES-5- T1CR

SPDT

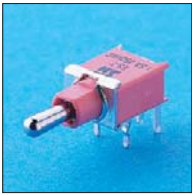

Model No.	Switching position		
ES-6	ON	none	ON
ES-6A	ON	OFF	ON
ES-6B	ON	None	(ON)
ES-6H	(ON)	OFF	(ON)
ES-6I	ON	OFF	(ON)
Term. Comm.	2-3	open	2-1

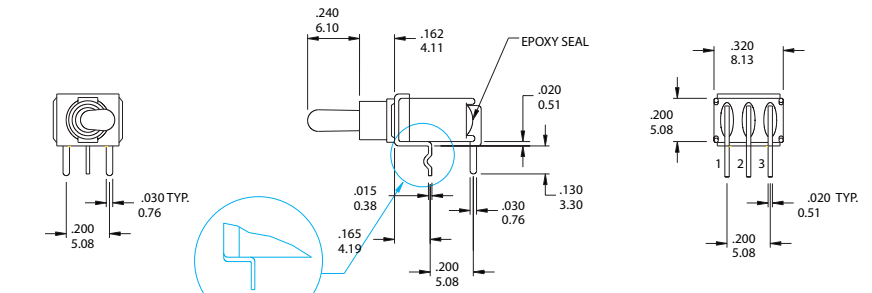
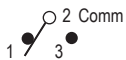

ES-6- T2R-S

DPDT

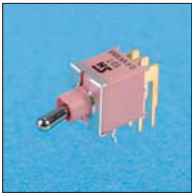

Model No.	Switching position		
ES-7	ON	none	ON
ES-7A	ON	OFF	ON
ES-7B	ON	None	(ON)
ES-7H	(ON)	OFF	(ON)
ES-7I	ON	OFF	(ON)
Term. Comm.	2-3,5-6	open	2-1,5-4
3 way switches (SP3T)			
ES-7C	ON	ON	ON
Term. Comm.	2-3,5-6	2-3,5-4	2-1,5-4

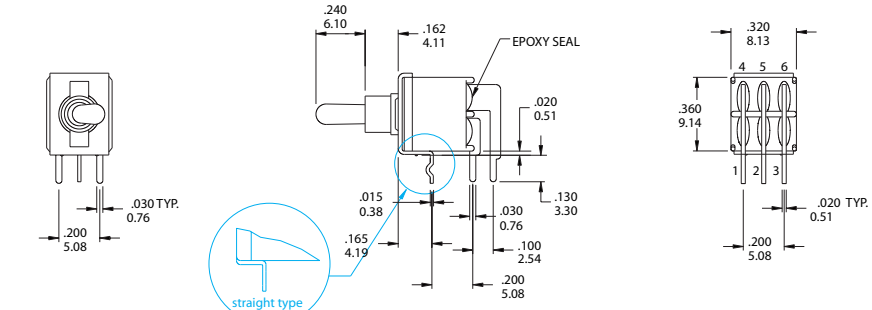

ES-7- T2R-S

SPDT

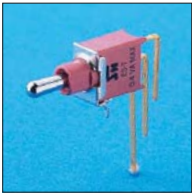

Model No.	Switching position		
ES-8	ON	none	ON
ES-8A	ON	OFF	ON
ES-8B	ON	None	(ON)
ES-8H	(ON)	OFF	(ON)
ES-8I	ON	OFF	(ON)
Term. Comm.	2-3	open	2-1

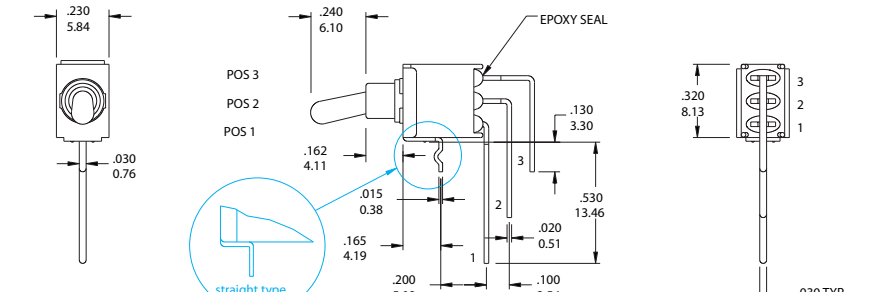
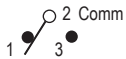

ES-8- T2R-S

DPDT



Model No.	Switching position		
ES-9	ON	none	ON
ES-9A	ON	OFF	ON
ES-9B	ON	None	(ON)
ES-9H	(ON)	OFF	(ON)
ES-9I	ON	OFF	(ON)
Term. Comm.	2-3,5-6	open	2-1,5-4
3 way switches (SP3T)			
ES-9C	ON	ON	ON
Term. Comm.	2-3,5-6	2-3,5-4	2-1,5-4

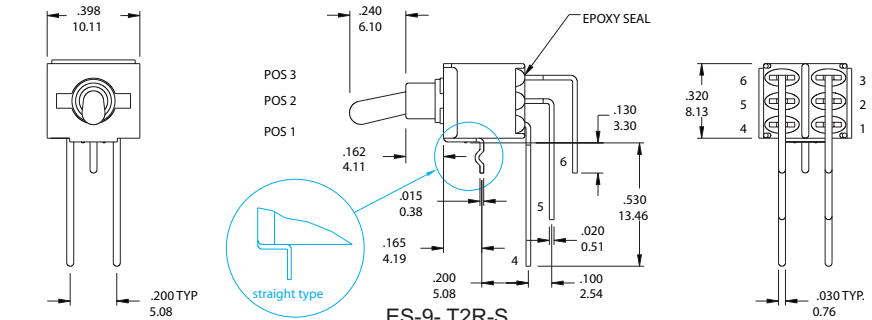

ES-9- T2R-S

INDEX TOGGLE

ROCKER

SLIDE

PUSHBUTTON

DIP

TACT



Actuator Option

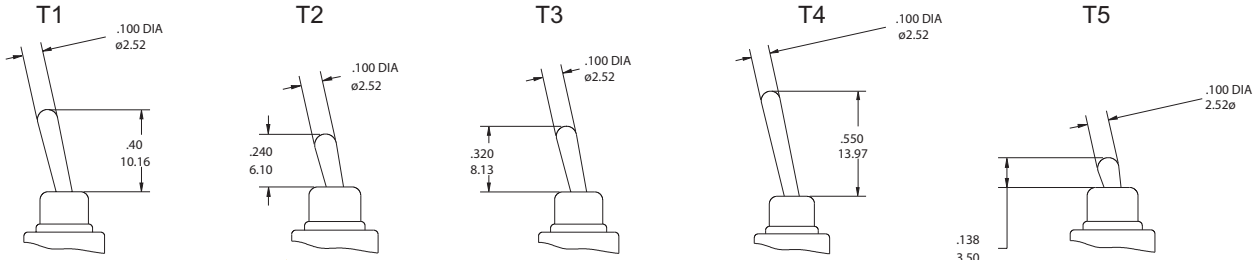

PLASTIC TOGGLE **NEW**

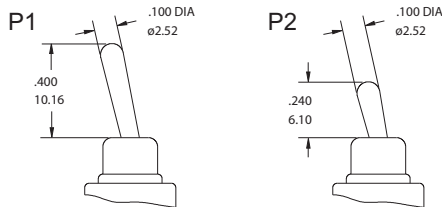

Material Nylon 4/6 (UL 94V-0), black std.
Static resistance: 9,000V DC min. @ sea level, actuator to terminals

code	description
P1/P2	black(std.)
P11/P21	white

Bushing dimension

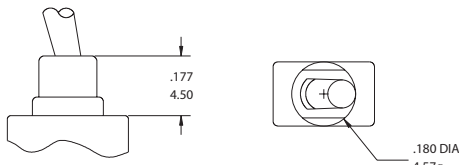

Terminal dimension

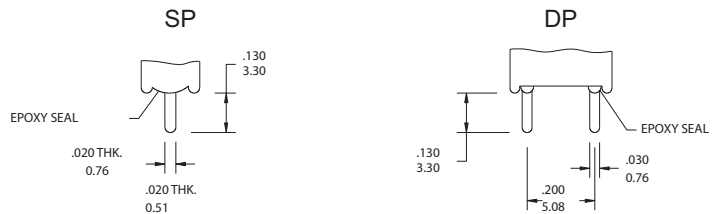

P.C.B Mounting Dimension

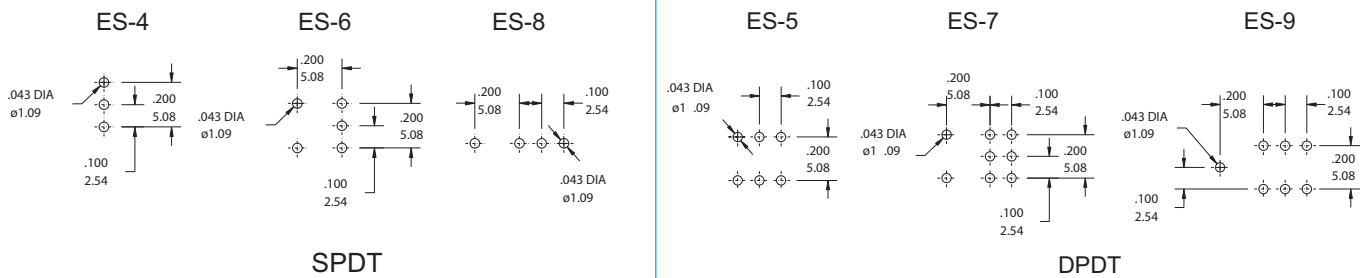

CONTACT MATERIAL OPTIONS

CODE	CONTACT MATERIAL	TERMINAL MATERIAL	RATING
Q	Silver plated	Silver plated	3 A @ 120V AC or 28 V DC; 1.5 A @ 250 VAC
R	Gold plated over nickel plated	Gold plated over nickel plated	0.4VA MAX @ 20 V AC or DC MAX
G	Gold plated over silver plated	Gold plated over silver plated	0.4 VA MAX @ 20 V AC or DC MAX or 3 A @ 120V AC or 28 V DC; 1.5 A @ 250 VAC
K	Gold plated over nickel plated	Tin over nickel plated	0.4VA MAX @ 20 V AC or DC MAX

* The "K" option is only for some special item. Please inquire first when you need the "K" option

VERTICAL SUPPORT BRACKET OPTION

A5

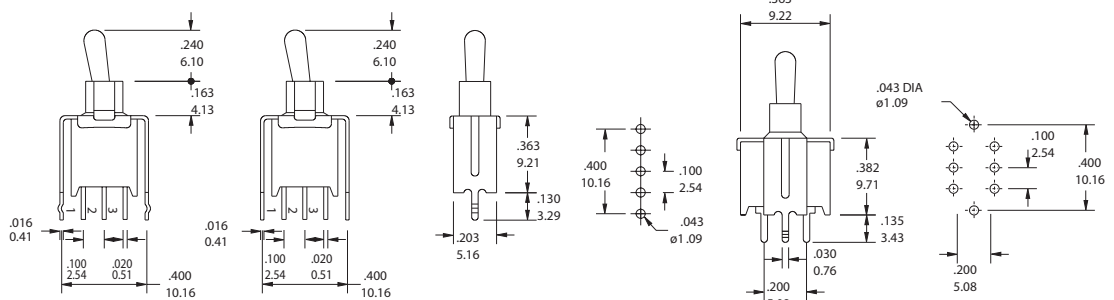
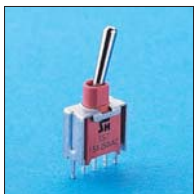

A5S (std.) snap-in type

A5 straight type

ES-4-T2CQ-A5S

ES-5-T2CQ-A5S