

# Serie 70



Cajas para montajes electrónicos de atractivo diseño y altas prestaciones que permiten aunar los conceptos industrial, electrónico y ofimático.

Fabricadas en ABS de alta calidad resistente hasta temperaturas de 85°C. Cumplen un grado de protección IP 65 mediante el montaje de juntas EPDM.

Segura y fácil fijación, entre tapa y base mediante tornillos, no vistos, e insertos M3.

Doble área de rebaje, tapa y base, que permiten y facilitan la fijación de teclados de membrana.

Doble sistema de montaje a pared, mediante pre-mecanizados estándar en la base o fijación exterior mediante escuadras (ABS).

Guías interiores para la fijación vertical de circuitos y torretas en tapa y base para fijación horizontal.

Color estándar: similar a gris RAL 7035 o negro RAL 9004.

Accesorios: - Junta EPDM (IP 65).  
- Kit fijación a pared.

Opciones: - Blindaje EMI/RFI.  
- ABS UL 94 V0.  
(Otras consulte a su distribuidor).

*A new range of enclosures in high impact ABS to meet various solutions within the Industrial Electronic and Electrical industries.*

*This range in ABS resistant up to 85°C and with 'O' ring gasket, will comply to IP 65 protection in respect of dust and moisture.*

*The two halves of the boxes are fixed together using M3 screws into machined inserts. These screw fixings are hidden by plastic covers.*

*A keyboard area of different sizes is provided on both the top and base of the box further increasing its flexibility.*

*Wall mounting facility is provided in two ways, either by separately designed feet or by precut holes in the base.*

*Guides for PCB in vertical mode are incorporated in the base and lid together with 5 mm high bosses for horizontal fixing.*

*Standard colour similar to RAL 7035 grey or RAL 9004 black.*

*Accessories: 'O' ring gasket (IP 65).  
Wall mounting kit.*

*Options: EMI/RFI shielding.  
UL 94 V0 materials.  
(Other please consult your dealer.)*

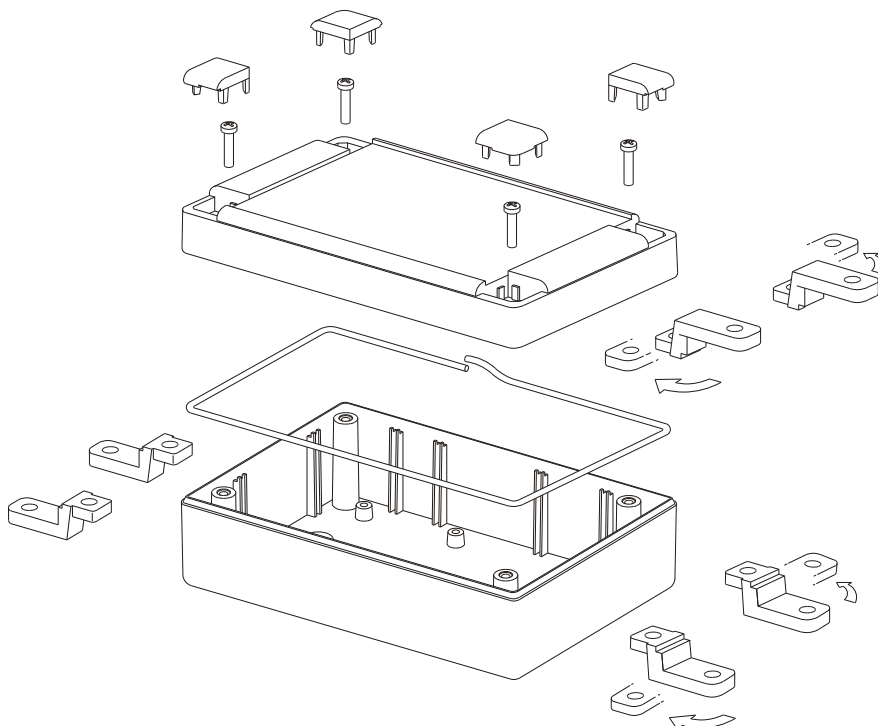

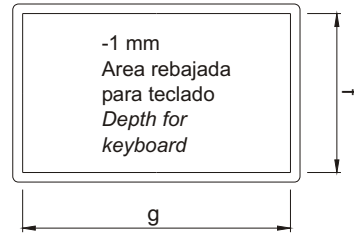
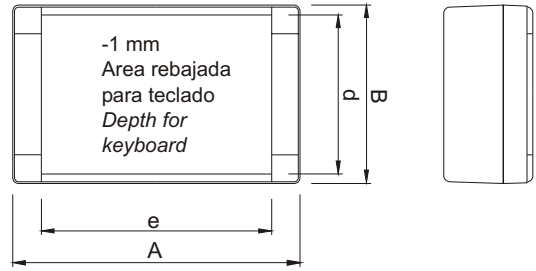
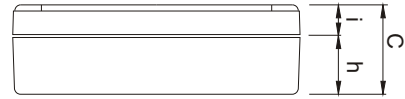

Serie 70 en color negro similar a RAL 9004.  
Serie 70 in black colour similar to RAL 9004.

Code	A	B	C	d	e	f	g	h	i
Gris claro Light grey RAL 7035									
Negro Black RAL 9004									
33070001	33070201	90	55	25	45.3	61.2	46.3	81.3	10.0
33070002	33070202	90	55	40	45.3	61.2	46.3	81.3	25.0
33070004	33070204	110	85	35	75.2	81.2	75.2	100.2	20.0
33070007	33070207	127	75	30	65.2	98.2	65.2	117.2	15.0
33070008	33070208	127	75	45	65.2	98.2	65.2	117.2	30.0
33070011	33070211	145	90	45	80.2	116.2	80.2	135.2	30.0
33070014	33070214	190	120	60	109.2	160.2	110.2	180.2	35.0
33070016	33070216	220	145	50	134.2	190.5	135.2	210.2	25.0
33070017	33070217	220	145	80	134.2	190.5	135.2	210.2	55.0

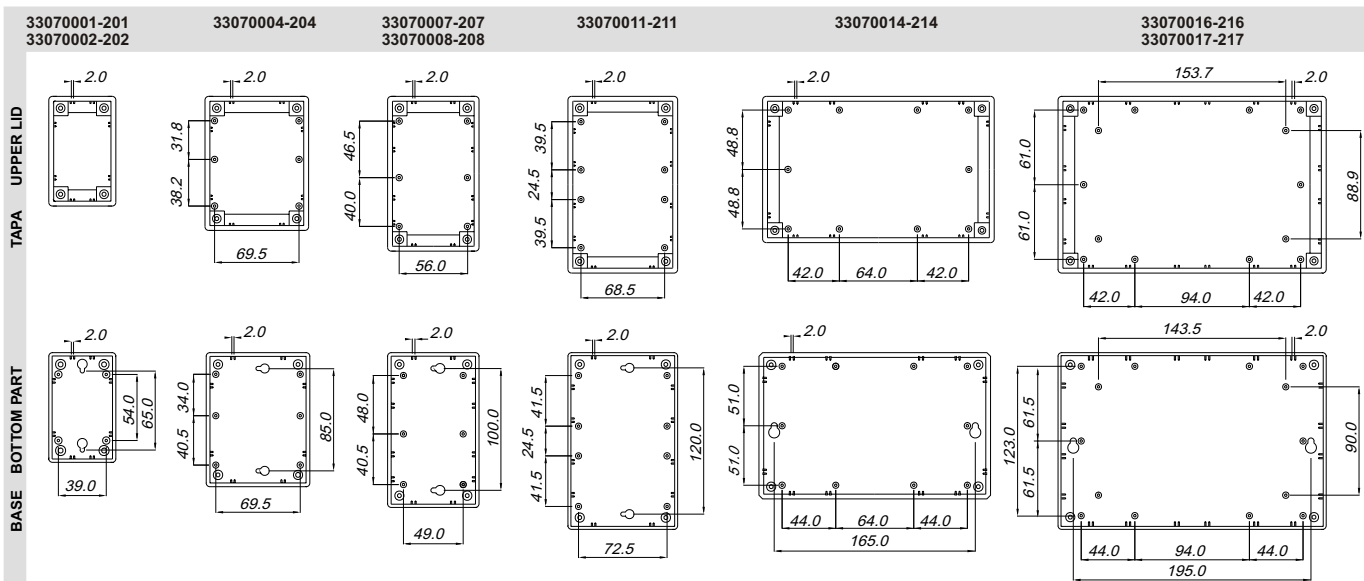

**Accesorios**  
**Accessories**

**JUNTA**  
**GASKET**

Fabricada en EPDM. Permite conseguir un elevado grado de protección frente al polvo, humedad y ozono.  
Soporta temperaturas de -20°C a +85°C.  
*Made in EPDM. It allows to achieve a high protection level against dust, humidity and ozon.*  
*Temperature range from -20°C to +85°C.*

Code	Para caja For enclosure
33070041	33070001 33070002
33070042	33070004
33070043	33070008
33070044	33070011
33070045	33070014
33070046	33070016 33070017

Montaje de junta  
Gasket fitting

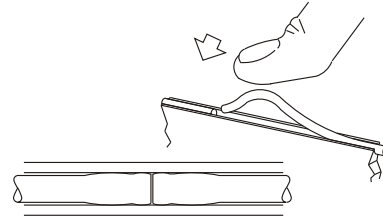
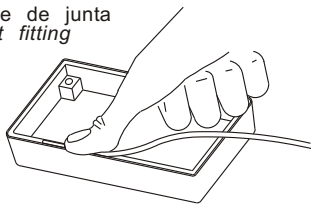

Asegurar presión  
Be sure of pressure

**FIJACION PARED**  
**WALL MOUNTING KIT**

Permite la fijación de los equipos a pared u otras estructuras. Separación entre caja y pared 1.5 mm (montaje en tapa) y 9.5 mm (montaje en base).  
Fabricado en ABS, color similar a gris RAL 7035 o negro RAL 9004.  
Adaptable a todos los tamaños excepto 33070001 y 33070002.

Code	Color Colour
33070200	Gris claro <i>Light grey</i> RAL 7035
33070300	Negro <i>Black</i> RAL 9004

(Premecanizados en base como alternativa).

*Allows the enclosure to be mounted to the wall or other structures. Distance between case and wall 1.5 mm -mounted from the lid- and 9.5 mm -mounted from the bottom.*  
*Made in ABS, colour similar to RAL 7035 grey or RAL 9004 black.*  
*Can be fitted to all sizes except 33070001 and 33070002.*

(Pre-cuts in bottom part as alternative).

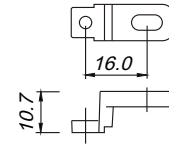

Montaje en tapa  
Upper lid mounting

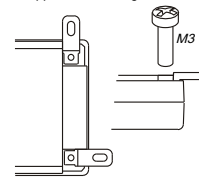

Montaje en base  
Bottom lid mounting

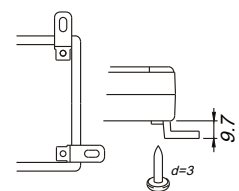

**KIT EMI/RFI**  
**EMI/RFI KIT**

(Bajo pedido)

(To order)